

Flat die plate, offset (solid die cavity)

Particularly useful where access to the component is difficult, e.g. C- and U-shaped sections, blanks with

90° offset, etc. Single tools, quick and easy to replace. Can be used for single and multiple points.

Special shapes possible on request.

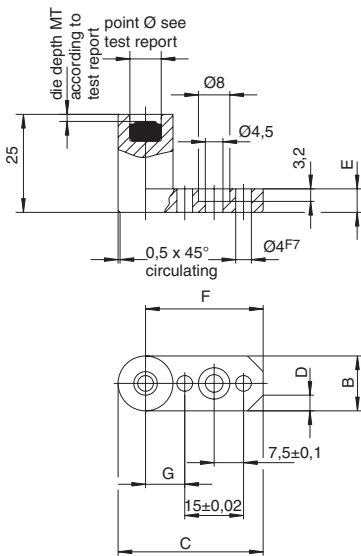

Order number Part 1 = design	B	C	D	E	F±0,02	G±0,02	H±0,02	for TOX® point Ø mm
TOX® 50.25	10	35	3x45°	6	30	10	25	3, 4, 5, (6)*
TOX® 51.25	14	37	4x45°	6	30	10	25	6, 8
TOX® 53.25	16	38	4,5x45°	10	30	10	25	10
TOX® 54.25	20	45	4,5x45°	10	35	15	30	12

* only after consulting TOX® PRESSOTECHNIK.

Dimensions in mm

Die with insert features an integrated oil drainage system.

Installation with groove

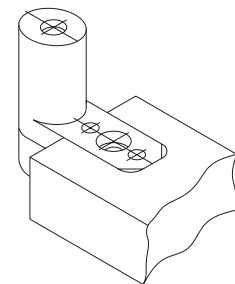
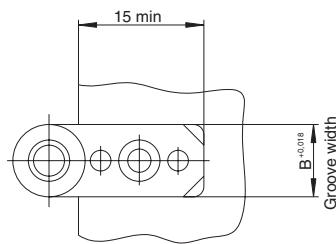
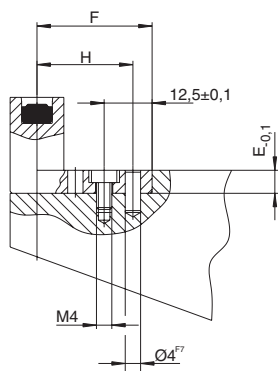

Installation with dowel pin

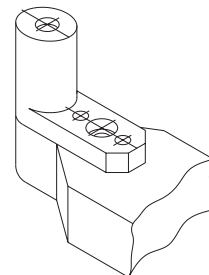
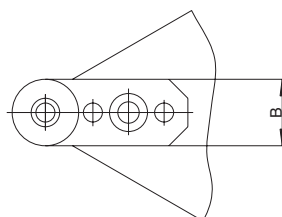
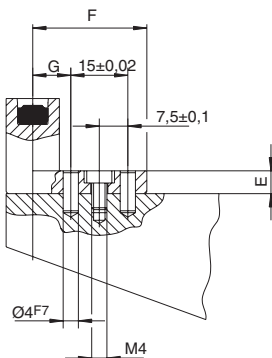

Attention: observe installation guidelines and TOX® test report